



LIFTPARKER N4403

THE IDEAL SOLUTION IN 3 PLATFORM LEVELS FOR DEEPER PITS AND HIGH CLEAR HEIGHTS



SHORT DESCRIPTION

INDEPENDENT PARKING ON 3 LEVELS
LESS COLUMN HEIGHT FOR MORE FLEXIBILITY
HORIZONTALLY ACCESSIBLE PLATFORMS
SINGLE SYSTEM (3 CARS), DOUBLE SYSTEM (6 CARS)
LOAD PER PARKING SPACE: 2.000 KG (STANDARD)
UP TO 2.600 KG (S-SYSTEM)

APPLICATION

FOR INTERIORS, WITH PIT
ONE AND MULTI-FAMILY DWELLINGS
HOTELS AND OFFICE BUILDINGS
CONDOMINIUMS AND COMMERCIALS
ABOVEGROUND AND READYMADE GARAGES
FOR PERMANENT USERS ONLY

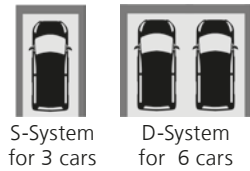

NOTE
The total height of the car including roof rail and antenna fixture must not exceed the maximum car height mentioned in the table below. Standard cars do not feature sport equipment (e.g. spoiler, etc.).



Load per parking space: max. 2.000kg, wheel load: max. 500kg.

N4403-E: Optional up to max. 2.600kg, wheel load: max. 650kg.

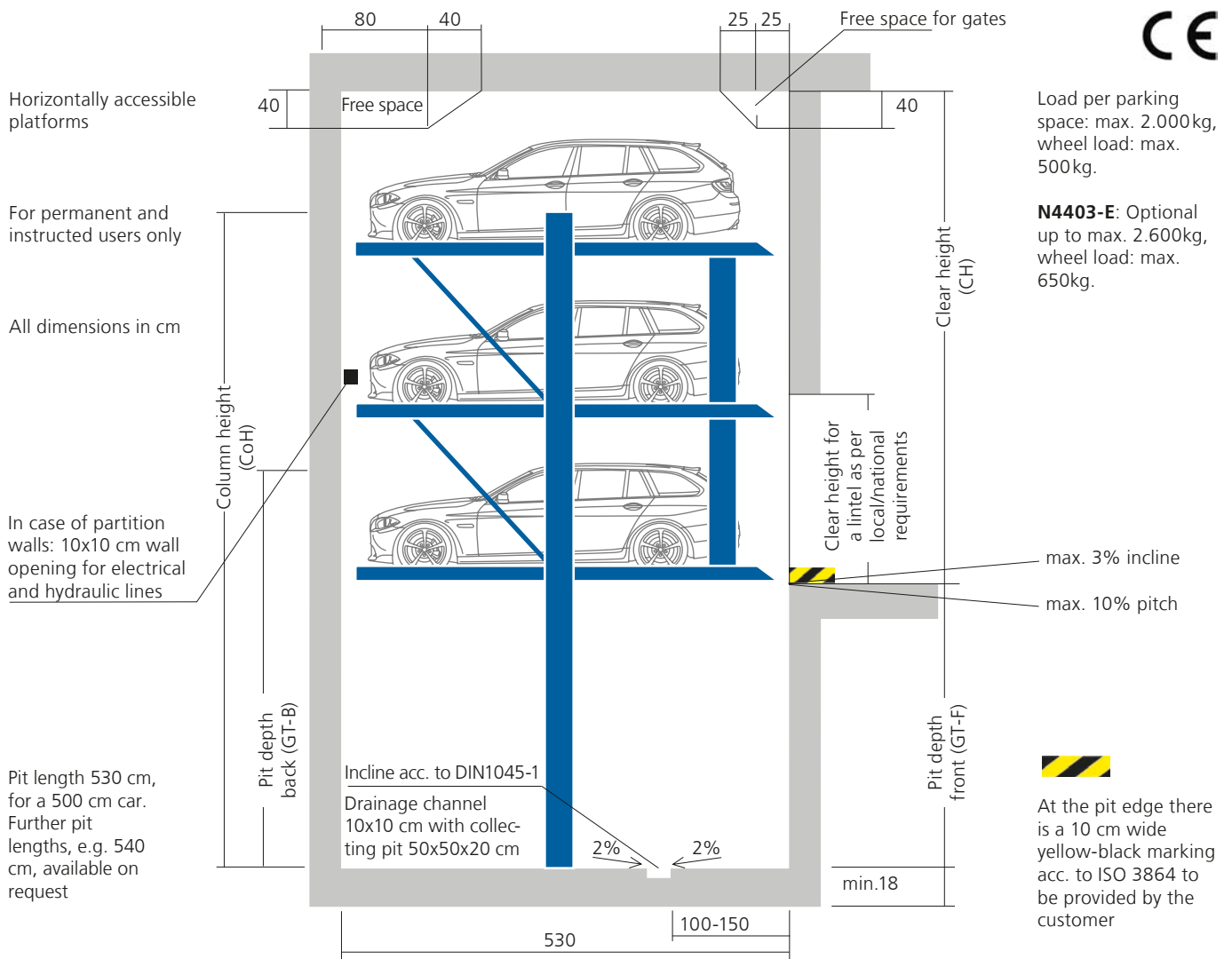

PIT DEPTH FRONT (GT-F)	PIT DEPTH BACK (GT-B)	CLEAR HEIGHT (CH)	COLUMN HEIGHT (CoH)	CAR HEIGHT BELOW		CAR-HEIGHT MIDDLE		CAR HEIGHT ABOVE
				S-SYSTEM	D-SYSTEM	S-SYSTEM	D-SYSTEM	
335	330	from 485	530	153	150	153	150	from 150
345	340	from 505	550	158	155	158	155	from 150
355	350	from 515	570	163	160	163	160	from 150
375	370	from 535	590	173	170	173	170	from 150
385	380	from 545	600	178	175	178	175	from 150

In case higher clear height is available it is possible to park correspondingly higher cars on the upper platform.

VEHICLE DATA: STANDARD CAR

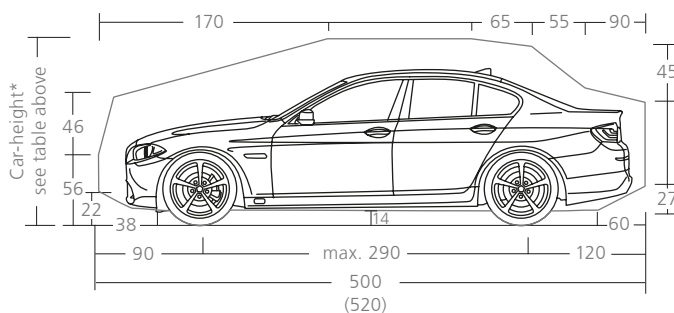

VEHICLE DATA: STANDARD ESTATE CAR

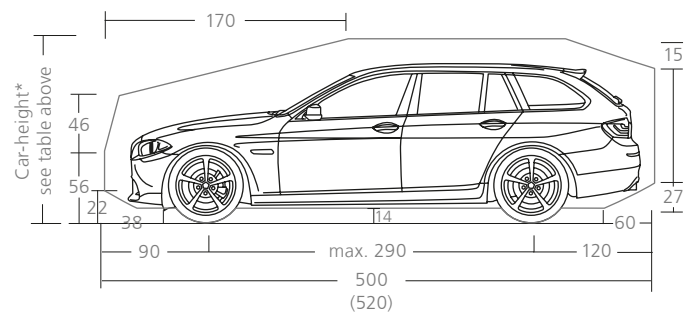

ELECTRICAL INSTALLATION AND FOUNDATION LOADS

Services covered by the NU-SPACE Company

POS.	QUANTITY	DESCRIPTION
1	1x	Hydraulic power unit with three-phase motor 230/400V, 50Hz, 6,0kW
2	1x	Control cable 4x 1,0 ² (Control by standard key-operated switch)
	option	Control cable 4x 1,0 ² (only with lockable key-operated switch)
3	1x	Control element

Positions 1 to 3 are covered by the NU-SPACE company unless otherwise agreed in the offer or in the contract.

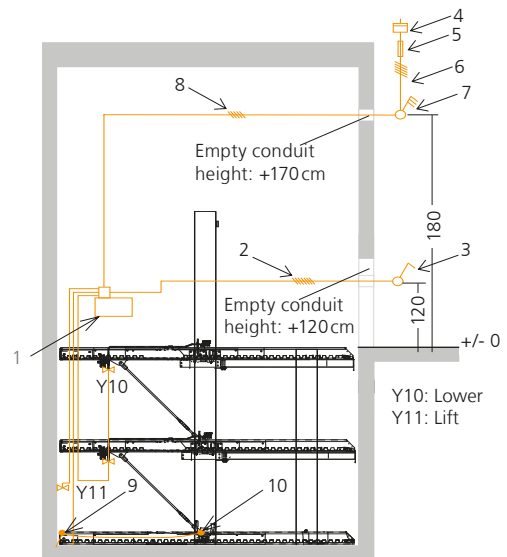

Services to be provided by the customer

POS.	QUANTITY	DESCRIPTION	POSITION	FREQUENCY
4	1x	Electricity meter	in the supply line	
5	1x	Blade fuse or circuit breaker 3x 25A, slow acc. to DIN VDE 0100 part 430	in the supply line	1x power unit
6	1x	Supply line 5x 4 mm ² (3 PH + N + PE) with marked leads + protective earth conductor	to the mains switch	1x power unit
7	1x	Lockable network facility (main control switch)	near power unit	1x power unit
8	1x	Supply line 5x 4 mm ² (3 PH + N + PE) with marked leads + protective earth conductor	to the power unit	1x power unit
9	1x	Foundation earth electrodes	pit floor corner	
10	1x	Equipotential bonding according to DIN EN 60204 from the connector of the foundation earth electrodes to the system	at the column foot	1x system

FOUNDATION LOADS AND CONSTRUCTION

Foundation and pit walls must be planned so that they can absorb the loads of the parking system according to the schematic diagram shown below. All forces are discharged to the ground by base plates with a minimum area of 150 cm². The base plates of the parking system are fastened with metal heavy duty anchor bolts; the borehole is approx. 14cm deep. Optionally the base plates can be fastened using shear connectors, e.g. in case of watertight concrete or increased noise insulation. The clarification of the fastening methods shall be provided by the customer, if necessary, the shear connectors can be delivered against surcharge.

Foundation, walls and ceilings shall be realized by the customer and completed prior to assembly start and must be true to size, clean and dry. Floor and walls (below the entrance level) made of armoured concrete, concrete quality at least: C25/30.

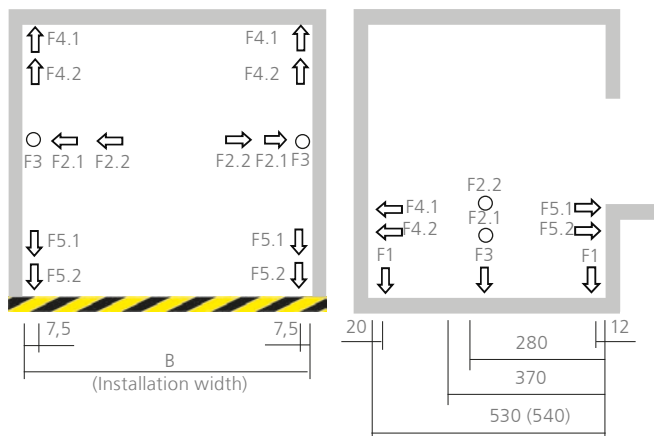

LOADS	S-SYSTEM 2.000KG	D-SYSTEM 2.000KG	S-SYSTEM 2.600KG
F1	15 kN	27,5 kN	15 kN
F2.1	10kN	9 kN	9 kN
F2.2	5 kN	5 kN	5 kN
F3	50 kN	90 kN	60 kN
F4.1	9 kN	15 kN	11 kN
F4.2	6 kN	10 kN	8 kN
F5.1	16 kN	30 kN	20 kN
F5.2	8 kN	15 kN	10 kN

Dimensions in cm.
All Dimensions are minimum dimensions.
Tolerances shall be taken into account additionally, see page „width dimensions for garages“.

WIDTH DIMENSIONS FOR GARAGES

All dimensions in cm. All dimensions are minimum dimensions. Advice for planning and tendering: Generally reinforced masonry and concrete works are to be performed according to German norm VOB/C (DIN 18330 and DIN 18331). In the norm mentioned the tolerances that are to be fulfilled according to DIN 18202 are pointed. In this norm the maximum exceedance and shortfall of the nominal size are defined. The nominal size should therefore be planned in order to meet the minimum dimensions necessary..

PARTITION WALLS

Single system for 3 cars



Double system for 6 cars

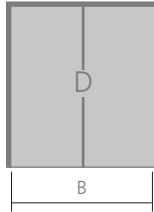

Double system + Single system for 9 cars

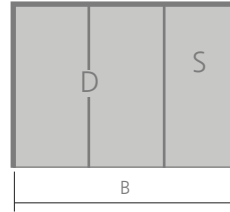

CLEAR PLAT-FORM WIDTH	INSTALLATION WIDTH B	CLEAR PLAT-FORM WIDTH	INSTALLATION WIDTH B	CLEAR PLAT-FORM WIDTH	INSTALLATION WIDTH B
230	270	460	500	460+230	760
		470	510	•	
240	280	480	520	480+240	790
		490	530	•	
250	290	500	540	500+250	820
260	300				
270	310				

Driving lane width acc. to country specific regulations.

Concrete haunches on the pit floor/wall joinings are not included. If these are necessary, this results in respectively a larger pit width or a narrower platform width.

BUILDING PILLARS INSIDE AS WELL AS IN FRONT OF THE PIT

Single system for 3 cars

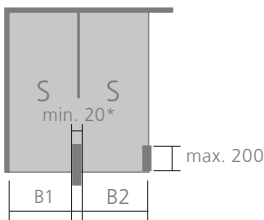

Double system for 6 cars

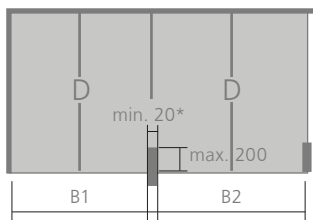

Double system + Single system for 9 cars

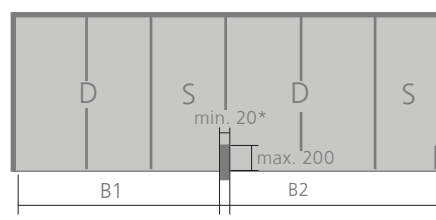

CLEAR PLAT-FORM WIDTH	B1	B2	CLEAR PLAT-FORM WIDTH	B1	B2	CLEAR PLAT-FORM WIDTH	B1	B2
230	265	260	460	495	490	460+230	755	750
			470	505	500	•		
240	275	270	480	515	510	480+240	785	780
			490	525	520	•		
250	285	280	500	535	530	500+250	815	810
260	295	290						
270	305	300						

Driving lane width acc. to country specific regulations.

* Building supports from 20cm width: no restrictions on the clear platform width according to the specifications in the charts.

• Intermediate stages can be combined at will.

Note: the dimensions reported do not include the space necessary for the power unit.

1-2 systems: 65 x 25 x 60 cm

During the planning phase please add the dimensions for the power unit incl. control cabinet.

3-5 systems: 115 x 25 x 60 cm

WIDTH DIMENSIONS FOR GARAGES WITH GATES

All dimensions in cm. All dimensions are minimum dimensions. Advice for planning and tendering: Generally reinforced masonry and concrete works are to be performed according to German norm VOB/C (DIN 18330 and DIN 18331). In the norm mentioned the tolerances that are to be fulfilled according to DIN 18202 are pointed. In this norm the maximum exceedance and shortfall of the nominal size are defined. The nominal size should therefore be planned in order to meet the minimum dimensions necessary..

SINGLE AND DOUBLE GARAGE

Single system for 3 cars

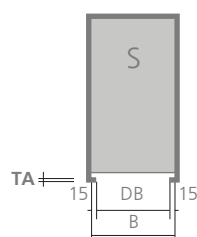

Double system for 6 cars

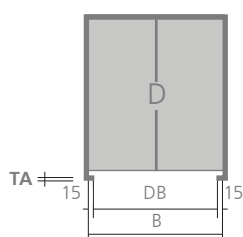

TA = seat engaging surface for gates.
Dimensions to be agreed on site with gate manufacturer.

Driving lane width acc. to country specific regulations.

Concrete haunches on the pit floor/wall joinings are not included. If these are necessary, this results in respectively a larger pit width or a narrower platform width.

CLEAR PLATFORM WIDTH	INSTALLATION WIDTH B	DRIVE-IN WIDTH DB	CLEAR PLATFORM WIDTH	INSTALLATION WIDTH B	DRIVE-IN WIDTH DB
230	270	230	460	500	460
			470	510	470
240	280	240	480	520	480
			490	530	490
250	290	250	500	540	500
260	300	260			
270	310	270			

GARAGES WITH SINGLE AND DOUBLE GATES

Single system for 3 cars

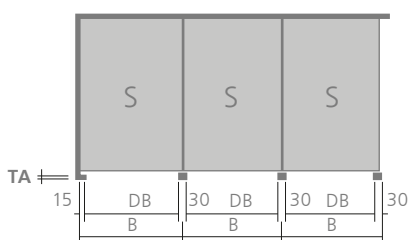

Double system for 6 cars

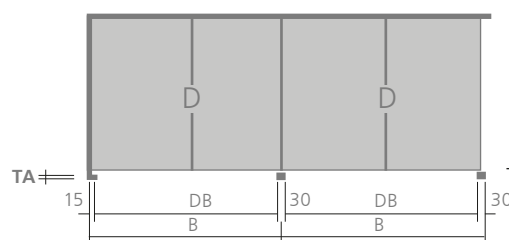

Driving lane width acc. to country specific regulations.

CLEAR PLATFORM WIDTH	INSTALLATION WIDTH B	DRIVE-IN WIDTH DB	CLEAR PLATFORM WIDTH	INSTALLATION WIDTH B	DRIVE-IN WIDTH DB
230	270	230	460	500	460
			470	510	470
240	280	240	480	520	480
			490	530	490
250	290	250	500	540	500
260	300	260			
270	310	270			

Note: the dimensions reported do not include the space necessary for the power unit.

1–2 systems: 65 x 25 x 60 cm

During the planning phase please add the dimensions for the power unit incl. control cabinet.

3–5 systems: 115 x 25 x 60 cm

STANDARD FEATURES – IN THE SCOPE OF DELIVERY

COMPONENT PARTS

- Single system: consisting of 3 Platforms, 2 packed columns with hydraulic cylinders, lifting slide and hydraulic block, 2 rigid pillars aside platforms and/or:
- Double system: consisting of 6 Platforms, 2 packed columns with hydraulic cylinders, lifting slide and hydraulic block, 2 rigid pillars aside platforms.

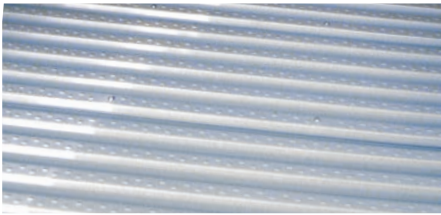

Platforms with sidewalls and driving sheets made of trapezoidal sheet.

DIMENSIONS OF THE SYSTEM

Parking space length: 500 cm
 Parking space width: 230 cm (for max. 190 cm wide cars)
 Pit depth: 335/330 cm
 Load per parking space: 2.000 kg.

KEY SWITCH



Control unit composed of key-switch with Emergency-off in dead-man's control and with cabling to the hydraulic power unit.

HYDRAULIC POWER UNIT INCL. ELECTRICAL SWITCH BOX

Power unit „Silencio“



With hydraulic canalization and with cabling to the main control switch. (The under oil unit is not loud thanks to the motor-pumps-combination that absorbs sound and insulates form noise). Electrical switch box included in delivery.

Measurements of the power unit:

1–2 systems: 65 x 25 x 60 cm
 3–5 systems: 115 x 25 x 60 cm.

The power unit will be placed in the pit between 2 systems on an approx. 2 m high pillar or, if there is no space available, it will be fastened to the wall. In case of single installations we can also optionally deliver a mobile power unit, installed on the lower platform, on its front left side.

CORROSION PROTECTION

C3-Line

For Regions with average snowfall and humidity levels (standard in Germany).

C2-Line

Recommended only for regions with small or no snowfall and low humidity levels.

NOTE

We suggest periodical maintenance, care and cleaning. Take advantage of NU-SPACE maintenance agreements.

ELECTRICAL INSTALLATION

For a list of services and interfaces please see the respective table in this brochure.

DOCUMENTATION

Brief operating instructions (fastened at the control unit), documentation (test book and operating instructions).

SAFETY DEVICES

- Synchronization unit to guarantee synchronous run even in case of irregular load distribution.
- Wedge to help position the vehicle.



- Safety device to avoid lowering in case of pipeline rupture.
- Fastening of the parking system and hydraulic power unit with stud-bolts, electrical cabling fastened with impact dowels.
- Handrails on the platforms where necessary to avoid danger of falling down from the system.

Note:

- Safety fences against shear and crushing points are a priority and must be provided by the customer.
- Hydraulic package „Parallelbetrieb“: Symultaneous lowering of 2 or more systems per power unit with appropriate pump capacity.

OPTIONS AND EXTRA EQUIPMENT – EXAMPLES

DIMENSIONS OF THE SYSTEM

Parking space lengths: 510 to 540 cm
 Parking space widths: 240 to 250 cm
 (S-system up to 270 cm)
 Parking space heights: 165 to 205 cm
 Pit depths: 345/340 up to 385/380 cm.

Fastening of the parking system with chemical anchors in case of heightened foundation requirements and sound insulation.

VEHICLE WEIGHT

Higher load per parking space
 Up to 2.600 kg.

BERLIN CONTROL UNIT/ FIRE BRIGADE



Berlin control unit with weatherproof casing and pillar

- Control unit consisting of a lockable key switch (key can be taken off only in the basis position) with emergency-off in dead-man's control. Lifting and lowering by using the respective button.
- Weatherproof casing for the key switch.
- Supporting pillar for the key switch.

DRIVING SHEETS



Upper platforms with Aluminium-bulb plates driving sheets and special driving wedge to help position the vehicle.

EXTRA SOUND INSULATION



Sound insulation hood for the power unit

Airborne noise package - Haube
 For the power unit to reduce the airborne noise at the installation site.

Structure/borne noise package
 Measures to reduce the sound propagation from the parking system to the building.

Note

- In order to comply with the DIN 4109/A1 Table 4 - requirements for the allowed noise level in areas in need of protection from noises coming from the technical equipment, the perimetral parts of the garage building shall be built with a sound reduction index R_w' of at least 57 dB.

NOTE

We suggest periodical maintenance, care and cleaning. Take advantage of NU-SPACE maintenance agreements.

GARAGE GATES' INSTALLATION

Ramp if doorjamb are missing for the installation of the door slide rails. The pit must then be at least 535 cm long.

CORROSION PROTECTION

C4-Line: driving sheets powdered on both sides
 For regions with highly corrosive humidity levels.

CATWALK

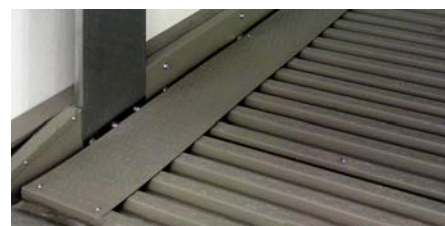

Catwalk on trapez. sheet for more walking comfort

Catwalk on trapezoidal sheet flooring
 Positioned on the left side of the parking space. 1,5 mm galvanized sheet, coined surface area. The Catwalk is bolted to the driving sheet.

HYDRAULIK

- HVL P 32-330 Öl for extreme temperature variations.
- Heated hydraulic power unit.

UPPER PLATFORM

- Even drive-on instead of drive-on ramp to allow a more comfortable entrance (this means a loss by 8 cm in the car-height on the middle platform).

SERVICES TO BE PROVIDED BY THE CUSTOMER AND PLANNING INDICATIONS

During the planning phase please observe and comply with the following notes!

SERVICES TO BE PROVIDED BY THE CUSTOMER

Safety fences

Safety fences acc. to DIN EN ISO 13857 must be provided by the customer.

Parking spaces' numeration

For the allocation of the parking spaces we suggest our customers to numerate the parking spaces.

Noise abatement measures

The compliance with these measures must be carried out by the customer acc. to norm DIN 4109: „Sound insulation in building construction“.

Lighting

To be carried out by the customer acc. to DIN 67528: „Lighting for parking areas and indoor car parks“.

Pit-foundation

To be carried out by the customer acc. to the specifications in this brochure.

Electrical installation

Prior to starting the assembly the customer must provide a lockable main control switch out of the system/pit and close to the power unit. Electrical services to be provided by the customer acc. to this brochure's spec.

Installation requirements

The compliance with installation requirements acc. to quotation.

Drainage

Drainage channel 10 cm x 10 cm with collecting pit 50 cm x 50 cm x 20 cm acc. to this brochure's spec to be carried out by the customer.

Fire protection

The customer must agree upon the fire protection requirements and the required measures with the local fire department and realise them.

Marking

The customer must provide a 10 cm wide yellow-black marking on the front pit edge according to the norm ISO 3864.

Wall openings

In case of partition walls the customer must realise a 10 cm x 10 cm wall opening for hosting hydraulic and electrical cables.

Building permit

The customer must apply for and get the required permits in order to allow the installation of the parking system.

Control unit

The customer must make sure that a plan surface of (L x W) 50 cm x 20 cm for the installation of the control unit is directly close to the power unit and out of the platforms' moving area.

PLANNING INDICATIONS

Parking space width and driving lanes

While planning the parking space and driving lane dimensions please observe and comply with the local/national prescriptions for the Garages' construction. For more parking comfort we suggest you to plan parking spaces of at least 250 cm width.

Group of users

Our parking systems are conceived for a permanent and instructed group of users.

Maintenance and care

We suggest a timely conclusion of a maintenance agreement.
We suggest also to perform maintenance, care and cleaning at regular time intervals.

EG-Machinery directive

Our parking systems comply with the EG-Machinery directive and are CE certified according to the norm DIN EN 14010.

Ramps' inclination

Ramps leading to garages shall not have more than 15% inclination.

Modifications

The company NU-SPACE reserves the right to make dimensional, design and technical modifications.